

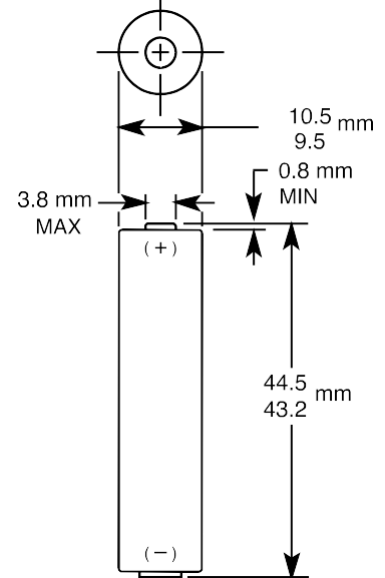

Dimensions shown are IEC standards

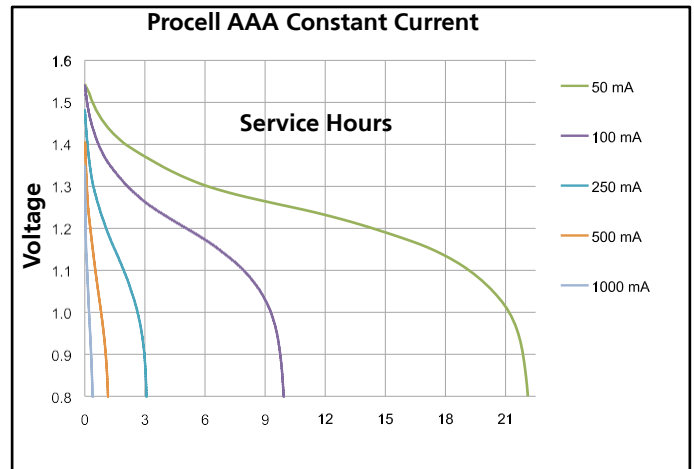

Nominal voltage	1.5 V
Impedance	250 m-ohm @ 1 kHz
Typical weight	11 g (0.4 oz)
Typical volume	3.5 cm <sup>3</sup> (0.2 in <sup>3</sup> )
Terminals	Flat
Storage temperature range	5°C to 30°C (41°F to 86°F)
Operating temperature range	-20°C to 54°C (-4°F to 130°F)
Designation	IEC: LR03

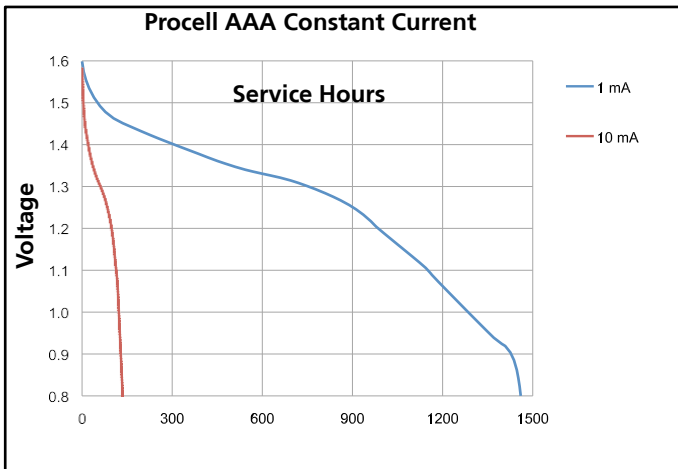

Berkshire Corporate Park  
Bethel, CT. 06801 U.S.A.  
Telephone: Toll-free 1-800-544-5454  
[www.duracell.com](http://www.duracell.com)

Delivered capacity is dependent on the applied load, operating temperature and cut-off voltage. Please refer to the charts and discharge data shown for examples of the energy/service life that the battery will provide for various load conditions.

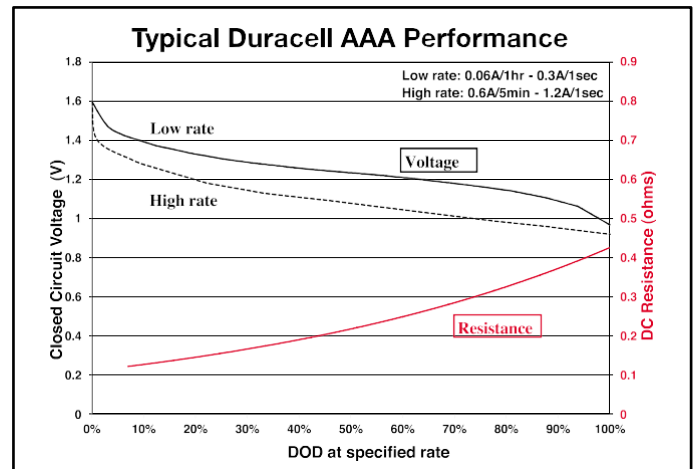
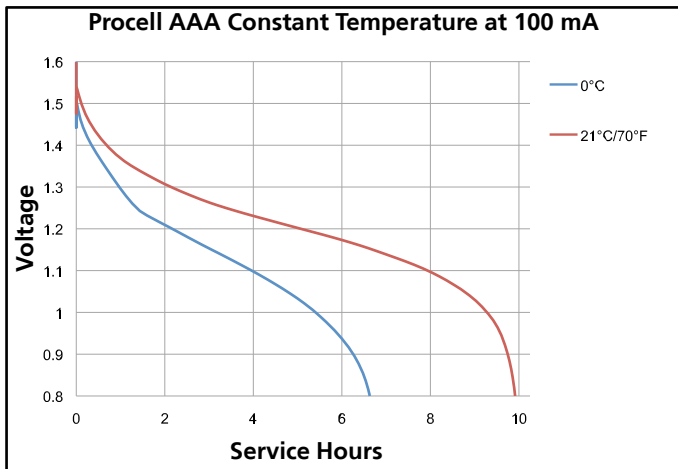
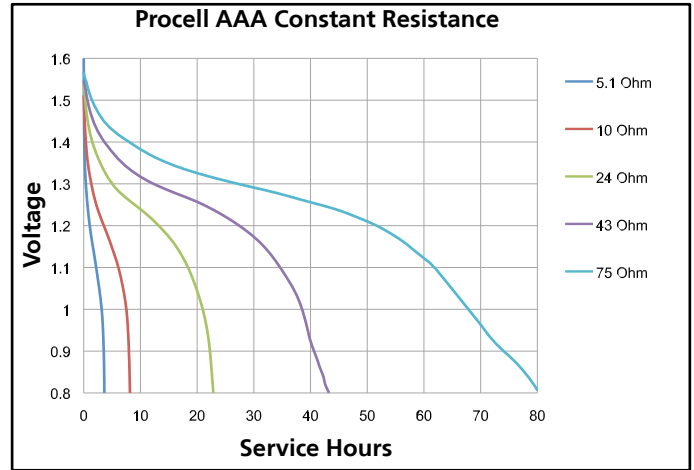
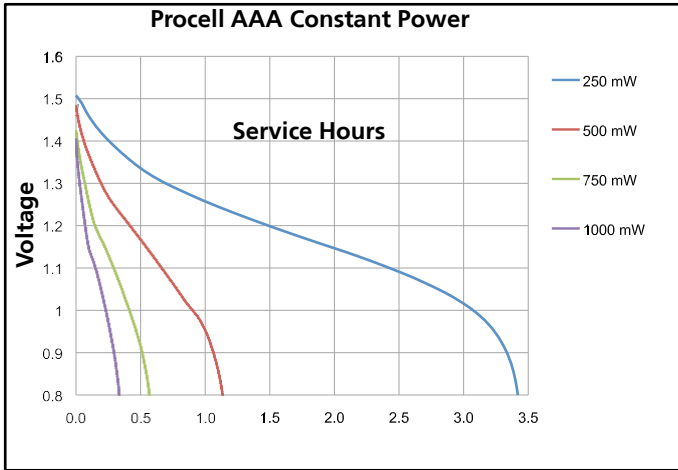

**DURACELL**®  
BATTERIES

Berkshire Corporate Park  
Bethel, CT. 06801 U.S.A.  
Telephone: Toll-free 1-800-544-5454  
[www.duracell.com](http://www.duracell.com)

Delivered capacity is dependent on the applied load, operating temperature and cut-off voltage. Please refer to the charts and discharge data shown for examples of the energy/service life that the battery will provide for various load conditions.